

TIZIT 1



# TIZIT Index

Each of the seven TIZITs shown here (in reduced size) has three close “cousins.” For example TIZITs 1,2,3 and 4 all have the same shape, but different orientations, different labeling of the points and unique drawing instructions.

1986 Mac Oglesby

TIZIT 5

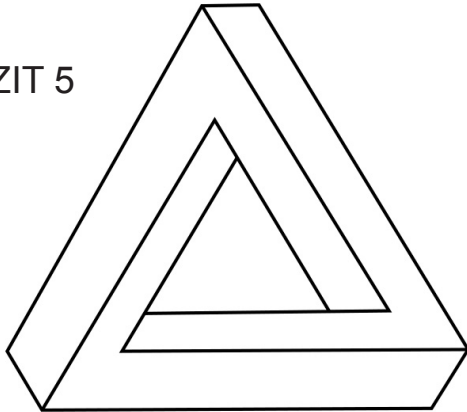

TIZIT 17

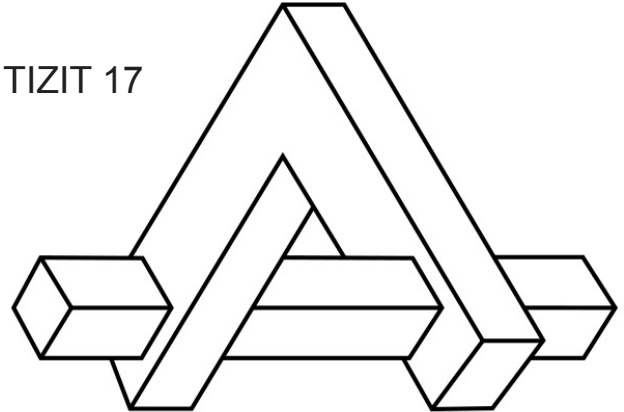

TIZIT 9

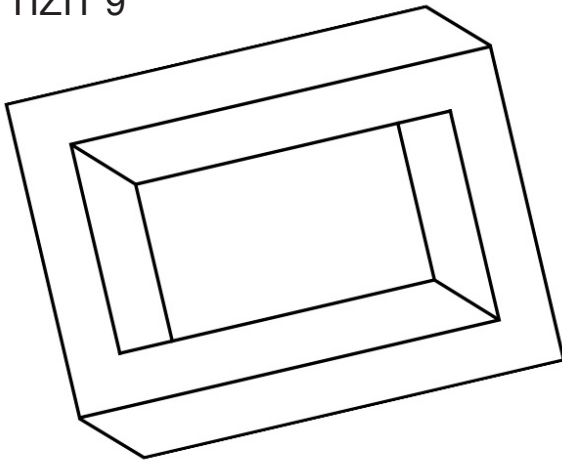

TIZIT 21

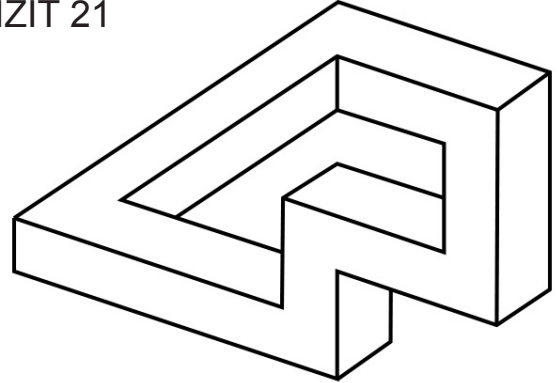

TIZIT 13

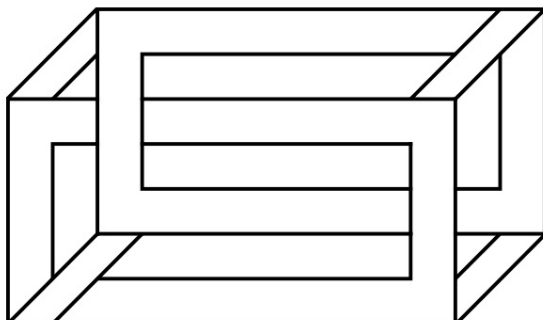

TIZIT 25

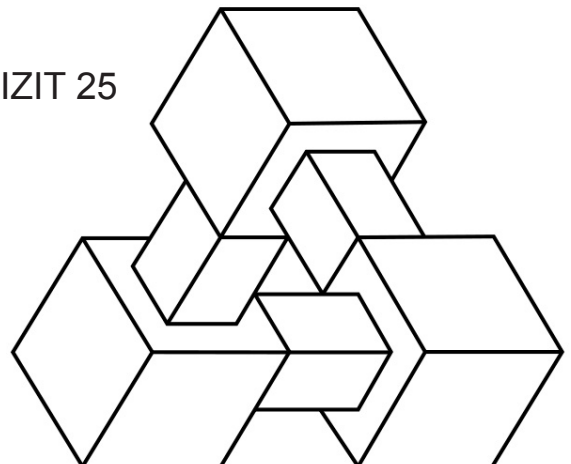

1 271501

The Westminster Whimsy Works produces pictures of irrational objects. These drawings are marketed worldwide under the trademark, "TIZIT", which, of course, comes from the exclamation, "What is it?"

Let's make a picture of a TIZIT now.

First draw football shapes between the points at EG, AB, and LM.  
Then draw these segments: CH, EK, CI, FJ, FL, GH, JM, DH, JK, AD, BC.

K.		.E
	H.	.G
	C.	.B
	D.	.I
J.		.A
	F.	.M
		.L

5 465268.

The Westminster Whimsy Works produces pictures of irrational objects. These drawings are marketed worldwide under the trademark, "TIZIT", which, of course, comes from the exclamation, "What is it?"

Let's make a picture of a TIZIT now.

Draw these segments: DJ, FI, CJ, DE, EG, BL, HK, BK, EF, GK, AC, HJ.

K. .H

F.

A.

L.

.I .B

G.

C.

.J

E.

.D

9 289590.

The Westminster Whimsy Works produces pictures of irrational objects. These drawings are marketed worldwide under the trademark, "TIZIT", which, of course, comes from the exclamation, "What is it?"

Let's make a picture of a TIZIT now.

Draw these segments: BK, JN, CL, CD, BJ, EH, HK, GH, AG, IM, DG, FN, BM, AM, JL, DF.

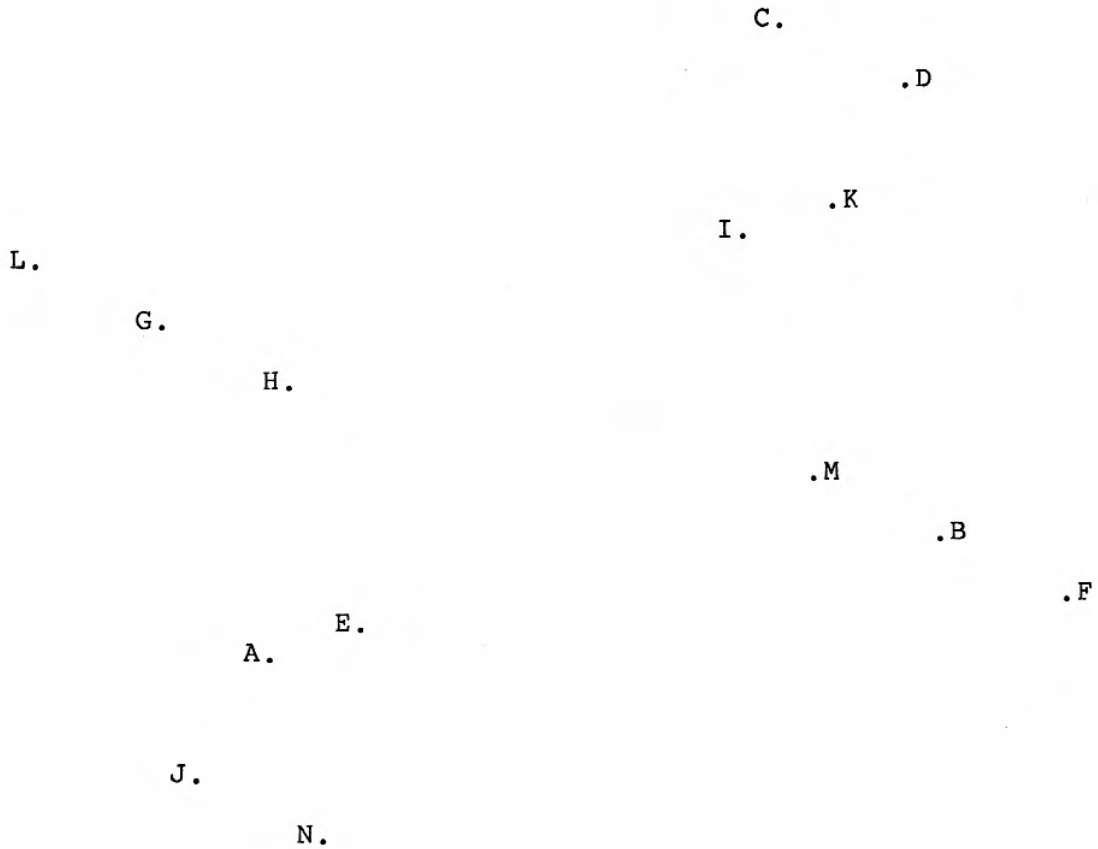

The Westminster Whimsy Works produces pictures of irrational objects. These drawings are marketed worldwide under the trademark, "TIZIT", which, of course, comes from the exclamation, "What is it?"

Let's make a picture of a TIZIT now.

Draw these segments: fC, RZ, dE, GV, gD, hI, DU, bL, gM, DP, PW, MZ, eZ, QV, XY, aO, fS, gW, BW, FK, AH, eP, dA, JT, eI, IM, KL, cN.

		g.					J.	.M
		a.	A.				.H	.Q
W.	O.	.B	h.			T.	.I	
	f.	.C	b.			.L		
			d.			.E	G.	.V
		D.	.X			.U	R.	.N .Z
	S.	F.				.K	c.	
P.	Y.						e.	

17 978858.

The Westminster Whimsy Works produces pictures of irrational objects. These drawings are marketed worldwide under the trademark, "TIZIT", which, of course, comes from the exclamation, "What is it?"

Let's make a picture of a TIZIT now.

Draw these segments: VX, WZ, KW, LU, fW, bD, DM, GX, cL, NO, gL, CF, aS, AC, KO, dN, OZ, DJ, PV, eQ, JY, FU, dZ, RT, BS, IM, cF, AH, TV, QS, AU, df, aE.

A. .C

Q.

E.

O. H..K G. e. X. Y. .J

N. Z. .W P. .V b. .D

d. B. .f R. g..T U. .F I. .M

S. .a L. .c

The Westminster Whimsy Works produces pictures of irrational objects. These drawings are marketed worldwide under the trademark, "TIZIT", which, of course, comes from the exclamation, "What is it?"

Let's make a picture of a TIZIT now.

Draw these segments: IM, MP, HR, AN, GQ, HS, EU, JU, HP, AE, NR, BV, LT, LS, KM, DV, NS, GL, BI, BO, EK, OQ, FT, CG.

P.  
L.  
G. .S  
V. .Q  
M. T. C. B. .D  
K. .F A. .O  
.I .J .R  
.U .N  
E.

